

Features

- Planar Die Construction
- 410mW Power Dissipation
- 2.4 – 51V Nominal Zener Voltage
- 5% Standard Vz Tolerance
- Designed for Surface Mount Application
- Plastic Material – UL Recognition Flammability Classification 94V-O

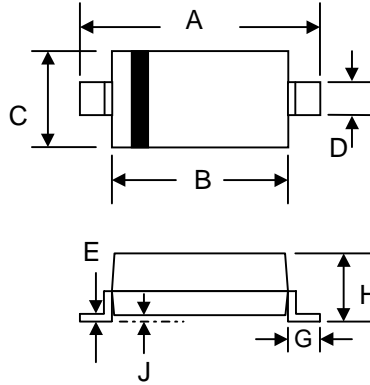

SOD-123		
Dim	Min	Max
A	3.6	3.9
B	2.5	2.8
C	1.4	1.8
D	0.5	0.7
E	—	0.2
G	0.4	—
H	0.95	1.35
J	—	0.12
All Dimensions in mm		

Mechanical Data

- Case: SOD-123, Molded Plastic
- Terminals: Plated Leads Solderable per MIL-STD-202, Method 208
- Polarity: Cathode Band
- Weight: 0.01 grams (approx.)
- Marking: Device Code, See Page 2
- **Lead Free: For RoHS / Lead Free Version, Add “-LF” Suffix to Part Number, See Page 5**

Maximum Ratings @ $T_A=25^\circ\text{C}$ unless otherwise specified

Characteristic	Symbol	Value	Unit
Peak Pulse Power Dissipation at $T_A = 25^\circ\text{C}$ (Note 1)	P_d	410	mW
Forward Voltage @ $I_F = 10\text{mA}$	V_F	0.9	V
Thermal Resistance Junction to Ambient (Note 1)	$R_{\theta JA}$	300	$^\circ\text{C/W}$
Operating and Storage Temperature Range	T_j, T_{STG}	-65 to +150	$^\circ\text{C}$

Note: 1. Diode on ceramic substrate 10mm x 8mm x 0.7mm.

Electrical Characteristics @ $T_A=25^{\circ}\text{C}$ unless otherwise specified

Type Number (Note 1)	Device Marking Code	Zener Voltage Range (Note 2)			Maximum Zener Impedance (Note 3)				Max Reverse Leakage Current		Temp. Coefficient of Zener Voltage @ I_{ZT} mV / $^{\circ}\text{C}$	
		$V_Z @ I_{ZT}$			$Z_{ZT} @ I_{ZT}$		$Z_{ZK} @ I_{ZK}$		I_R	@ V_R	Min	Max
		Nom (V)	Min (V)	Max (V)	(Ω)	(mA)	(Ω)	(mA)	(μA)	(V)		
BZT52C2V4	W1	2.4	2.28	2.52	85	5.0	600	1.0	100	1.0	-3.5	0
BZT52C2V7	W2	2.7	2.57	2.84	83	5.0	600	1.0	75	1.0	-3.5	0
BZT52C3	W3	3.0	2.85	3.15	95	5.0	600	1.0	50	1.0	-3.5	0
BZT52C3V3	W4	3.3	3.14	3.47	95	5.0	600	1.0	25	1.0	-3.5	0
BZT52C3V6	W5	3.6	3.42	3.78	95	5.0	600	1.0	15	1.0	-3.5	0
BZT52C3V9	W6	3.9	3.71	4.10	95	5.0	600	1.0	10	1.0	-3.5	0
BZT52C4V3	W7	4.3	4.09	4.52	95	5.0	600	1.0	5.0	1.0	-3.5	0
BZT52C4V7	W8	4.7	4.47	4.94	78	5.0	500	1.0	5.0	1.0	-3.5	0.2
BZT52C5V1	W9	5.1	4.85	5.36	60	5.0	480	1.0	0.1	0.8	-2.7	1.2
BZT52C5V6	WA	5.6	5.32	5.88	40	5.0	400	1.0	0.1	1.0	-2.0	2.5
BZT52C6V2	WB	6.2	5.89	6.51	10	5.0	150	1.0	0.1	2.0	0.4	3.7
BZT52C6V8	WC	6.8	6.46	7.14	8.0	5.0	80	1.0	0.1	3.0	1.2	4.5
BZT52C7V5	WD	7.5	7.13	7.88	7.0	5.0	80	1.0	0.1	5.0	2.5	5.3
BZT52C8V2	WE	8.2	7.79	8.61	7.0	5.0	80	1.0	0.1	6.0	3.2	6.2
BZT52C9V1	WF	9.1	8.65	9.56	10	5.0	100	1.0	0.1	7.0	3.8	7.0
BZT52C10	WG	10	9.50	10.50	15	5.0	150	1.0	0.1	7.5	4.5	8.0
BZT52C11	WH	11	10.45	11.55	20	5.0	150	1.0	0.1	8.5	5.4	9.0
BZT52C12	WI	12	11.40	12.60	20	5.0	150	1.0	0.1	9.0	6.0	10
BZT52C13	WK	13	12.35	13.65	25	5.0	170	1.0	0.1	10	7.0	11
BZT52C15	WL	15	14.25	15.75	30	5.0	200	1.0	0.1	11	9.2	13
BZT52C16	WM	16	15.20	16.80	40	5.0	200	1.0	0.1	12	10.4	14
BZT52C18	WN	18	17.10	18.90	50	5.0	225	1.0	0.1	14	12.4	16
BZT52C20	WO	20	19.00	21.00	50	5.0	225	1.0	0.1	15	14.4	18
BZT52C22	WP	22	20.90	23.10	55	5.0	250	1.0	0.1	17	16.4	20
BZT52C24	WR	24	22.80	25.20	80	5.0	250	1.0	0.1	18	18.4	22
BZT52C27	WS	27	25.65	28.35	80	5.0	300	1.0	0.1	20	21.4	25.3
BZT52C30	WT	30	28.50	31.50	80	5.0	300	1.0	0.1	22.5	24.4	29.4
BZT52C33	WU	33	31.35	34.65	80	5.0	325	1.0	0.1	25	27.4	33.4
BZT52C36	WW	36	34.20	37.80	90	5.0	350	1.0	0.1	27	30.4	37.4
BZT52C39	WX	39	37.05	40.95	90	5.0	350	1.0	0.1	29	33.4	41.2
BZT52C43	WY	43	40.85	45.15	100	5.0	700	1.0	0.1	32	10.0	12
BZT52C47	WZ	47	44.65	49.35	100	5.0	750	1.0	0.1	35	10.0	12
BZT52C51	XA	51	48.45	53.55	100	5.0	750	1.0	0.1	38	10.0	12

Note: 1. Type numbers listed have standard tolerance on the nominal zener voltage of $\pm 5\%$.

2. Measured with pulses $t_p = 5\text{ms}$.

3. $f = 1\text{KHz}$

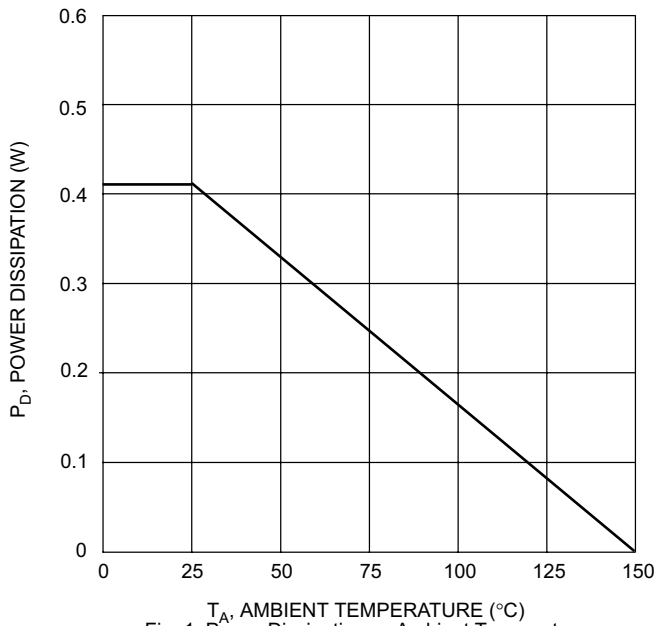

Fig. 1 Power Dissipation vs Ambient Temperature

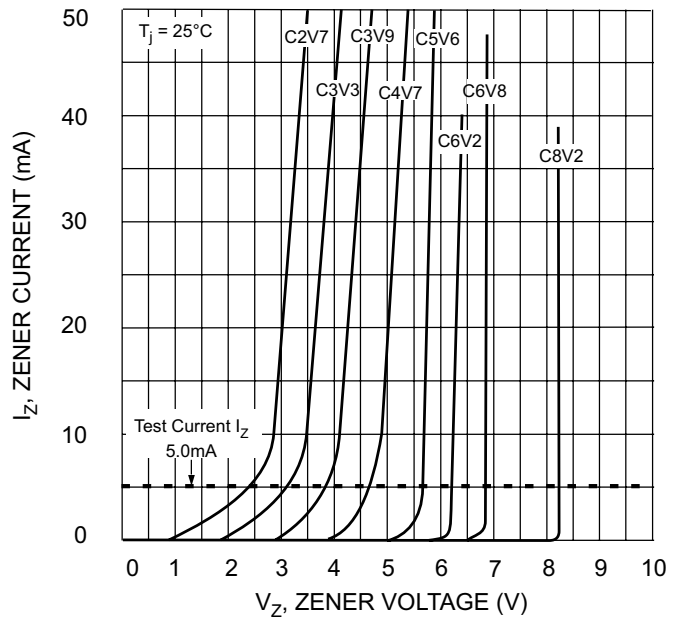

Fig. 2 Zener Breakdown Characteristics

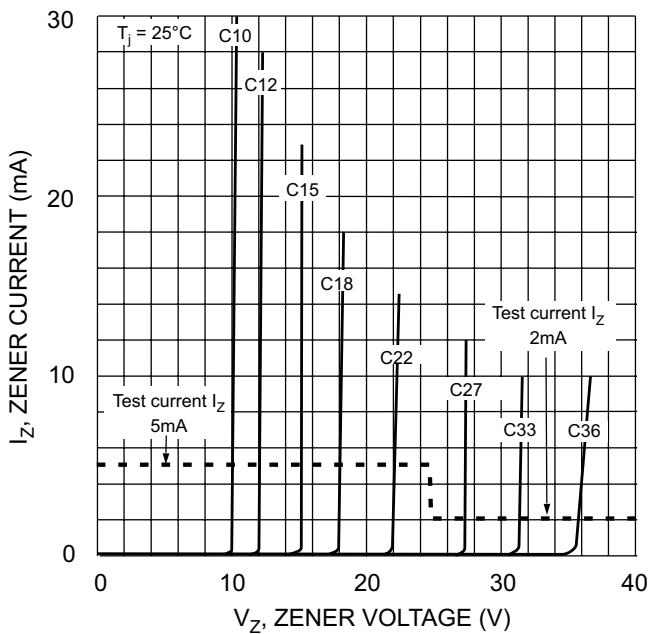

Fig. 3 Zener Breakdown Characteristics

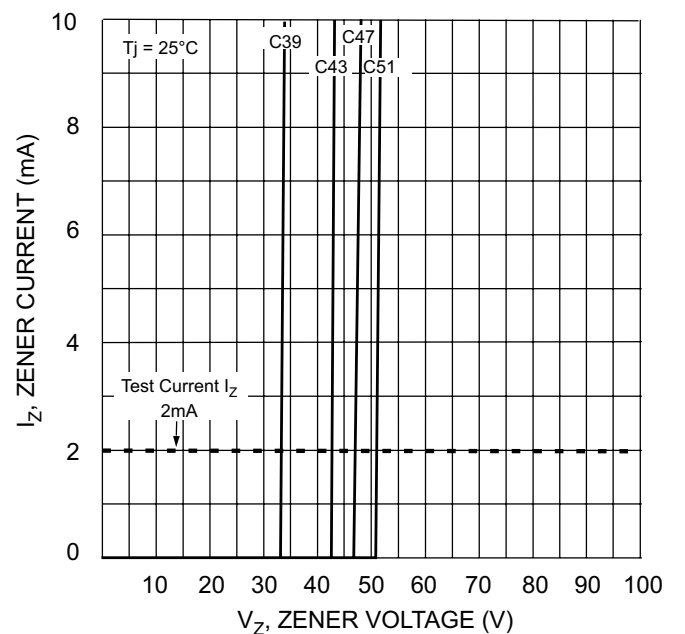

Fig. 4 Zener Breakdown Characteristics

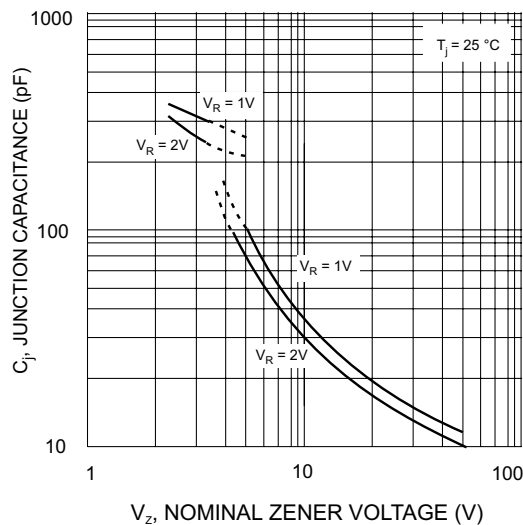

Fig. 5 Junction Capacitance vs Nominal Zener Voltage

MARKING INFORMATION



Cathode = Polarity Band
xx = Device Code, See Page 2

RECOMMENDED FOOTPRINT

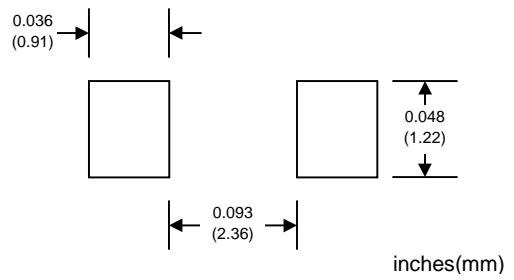

inches(mm)

PACKAGING INFORMATION

TAPE & REEL

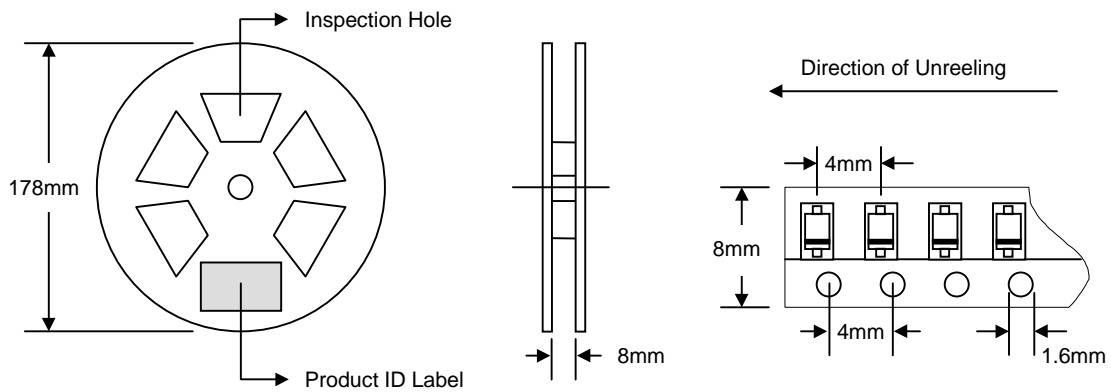

Reel Diameter (mm)	Quantity (PCS)	Inner Box Size L x W x H (mm)	Quantity (PCS)	Carton Size L x W x H (mm)	Quantity (PCS)	Approx. Gross Weight (KG)
178	3,000	187 x 187 x 65	15,000	390 x 240 x 420	150,000	10.0

Note: 1. Anti-static plastic reel, white, water clear or blue color. Inspection hole might be varied in different alignment.
2. Components are packed in accordance with EIA standard 481-1 and 481-2.

ORDERING INFORMATION

Product No.	Package Type	Shipping Quantity
BZT52Cxx-T1	SOD-123	3000/Tape & Reel

1. Shipping quantity given is for minimum packing quantity only. For minimum order quantity, please consult the Sales Department.
2. **To order RoHS / Lead Free version (with Lead Free finish), add "-LF" suffix to part number above. For example, BZT52C2V4-T1-LF.**

Won-Top Electronics Co., Ltd (WTE) has checked all information carefully and believes it to be correct and accurate. However, WTE cannot assume any responsibility for inaccuracies. Furthermore, this information does not give the purchaser of semiconductor devices any license under patent rights to manufacturer. WTE reserves the right to change any or all information herein without further notice.

WARNING: DO NOT USE IN LIFE SUPPORT EQUIPMENT. WTE power semiconductor products are not authorized for use as critical components in life support devices or systems without the express written approval.

Won-Top Electronics Co., Ltd.

No. 44 Yu Kang North 3rd Road, Chine Chen Dist., Kaohsiung, Taiwan

Phone: 886-7-822-5408 or 886-7-822-5410

Fax: 886-7-822-5417

Email: sales@wontop.com

Internet: <http://www.wontop.com>

We power your everyday.